

30V P-Ch Power MOSFET

Feature

- ◇ High Speed Power Switching, Logic Level
- ◇ Enhanced Avalanche Ruggedness
- ◇ Lead Free, Halogen Free

V_{DS}		-30	V
$R_{DS(on),typ}$	$V_{GS}=10V$	75	mΩ
$R_{DS(on),typ}$	$V_{GS}=4.5V$	125	mΩ
I_D (Silicon Limited)		-3.6	A

Application

- ◇ Load Switches
- ◇ Hard Switching and High Speed Circuit
- ◇ BLDC Motor

SOT-23

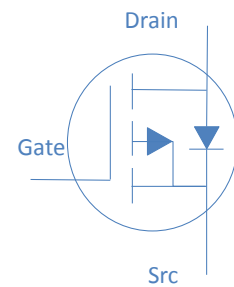
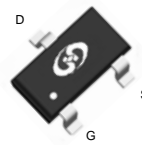

Part Number	Package	Marking
HTJ850P03	SOT-23	24

Absolute Maximum Ratings at $T_j=25^\circ\text{C}$ (unless otherwise specified)

Parameter	Symbol	Conditions	Value	Unit
Continuous Drain Current (Silicon Limited)	I_D	$T_A=25^\circ\text{C}$	-3.6	A
		$T_A=70^\circ\text{C}$	-2.5	
Drain to Source Voltage	V_{DS}	-	-30	V
Gate to Source Voltage	V_{GS}	-	± 20	V
Pulsed Drain Current	I_{DM}	-	-14	A
Power Dissipation	P_D	$T_A=25^\circ\text{C}$	1.04	W
Operating and Storage Temperature	T_J, T_{stg}	-	-55 to 150	$^\circ\text{C}$

Absolute Maximum Ratings

Parameter	Symbol	Max	Unit
Thermal Resistance Junction-Ambient	$R_{\theta JA}$	120	$^\circ\text{C/W}$

Electrical Characteristics at $T_j=25^\circ\text{C}$ (unless otherwise specified)
Static Characteristics

Parameter	Symbol	Conditions	Value			Unit
			min	typ	max	
Drain to Source Breakdown Voltage	$V_{(BR)DSS}$	$V_{GS}=0V, I_D=-250\mu A$	-30	-	-	V
Gate Threshold Voltage	$V_{GS(th)}$	$V_{GS}=V_{DS}, I_D=-250\mu A$	-1	-1.5	-3	
Zero Gate Voltage Drain Current	I_{DSS}	$V_{GS}=0V, V_{DS}=-24V, T_j=25^\circ\text{C}$	-	-	-1	μA
		$V_{GS}=0V, V_{DS}=-20V, T_j=125^\circ\text{C}$	-	-	-10	
Gate to Source Leakage Current	I_{GSS}	$V_{GS}=\pm 20V, V_{DS}=0V$	-	-	± 100	nA
Drain to Source on Resistance	$R_{DS(on)}$	$V_{GS}=-10V, I_D=-3.6A$	-	75	85	m Ω
		$V_{GS}=-4.5V, I_D=-2.5A$	-	125	145	
Transconductance	g_{fs}	$V_{DS}=-5V, I_D=-3A$	-	5	-	S

Dynamic Characteristics

Input Capacitance	C_{iss}	$V_{GS}=0V, V_{DS}=-15V, f=1\text{MHz}$	-	337	-	pF
Output Capacitance	C_{oss}		-	48	-	
Reverse Transfer Capacitance	C_{rss}		-	36	-	
Total Gate Charge	Q_g	$V_{DD}=-10V, I_D=-3A, V_{GS}=-10V$	-	5.1	-	nC
Gate to Source Charge	Q_{gs}		-	0.9	-	
Gate to Drain (Miller) Charge	Q_{gd}		-	1.1	-	
Turn on Delay Time	$t_{d(on)}$	$V_{DD}=-10V, I_D=-1A, V_{GS}=-10V, R_G=6\Omega,$	-	15	-	ns
Rise time	t_r		-	30	-	
Turn off Delay Time	$t_{d(off)}$		-	35	-	
Fall Time	t_f		-	30	-	

Reverse Diode Characteristics

Diode Forward Voltage	V_{SD}	$V_{GS}=0V, I_F=-2A$	-		-1.2	V
-----------------------	----------	----------------------	---	--	------	---

Fig 1. Typical Output Characteristics

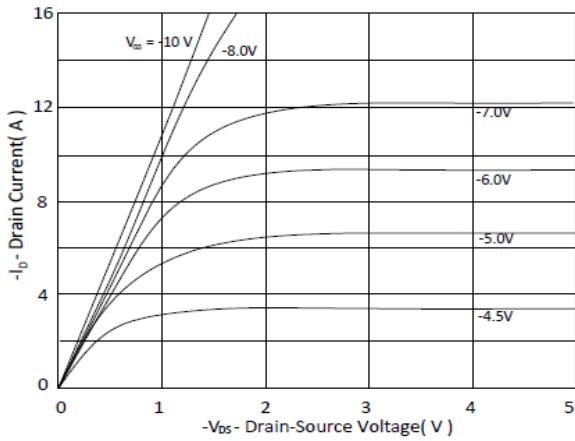

Figure 2. On-Resistance vs. Gate-Source Voltage

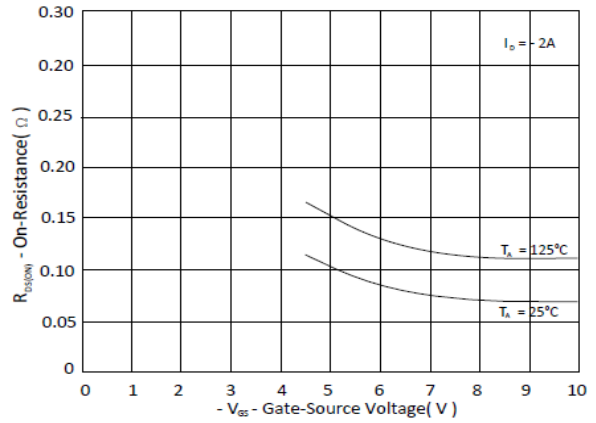

Figure 3. On-Resistance vs. Drain Current and Gate Voltage

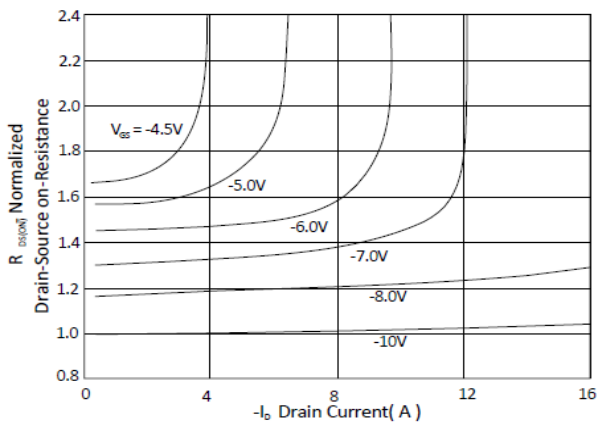

Figure 4. Normalized On-Resistance vs. Junction Temperature

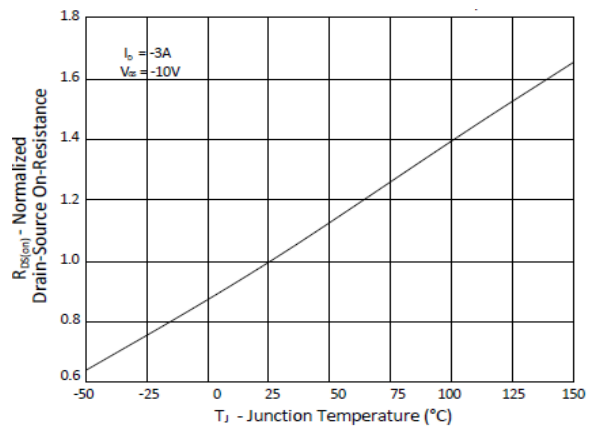

Figure 5. Gate Threshold Voltage v.s. Junction Temperature

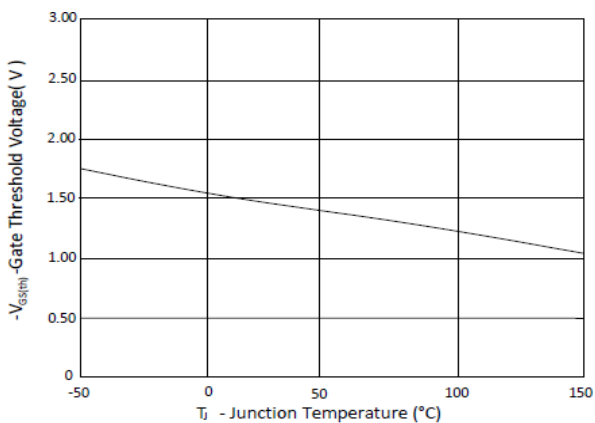

Figure 6. Typical Source-Drain Diode Forward Voltage

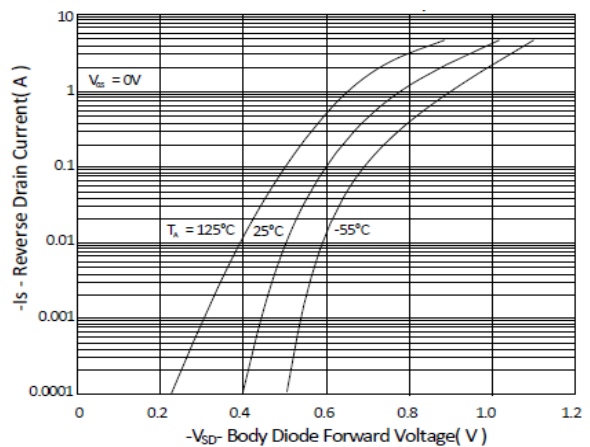

Figure 7. Typical Gate-Charge vs. Gate-to-Source Voltage

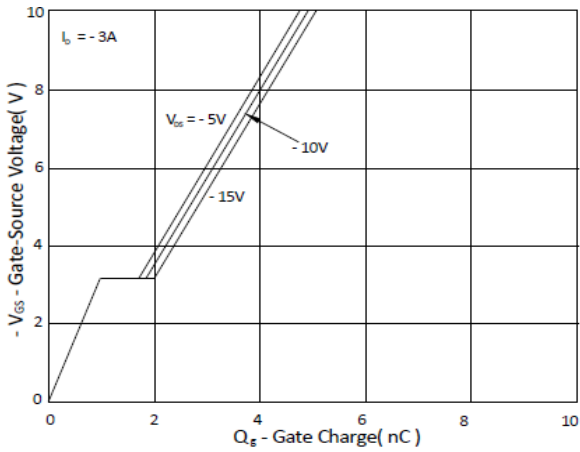

Figure 8. Typical Capacitance vs. Drain-to-Source Voltage

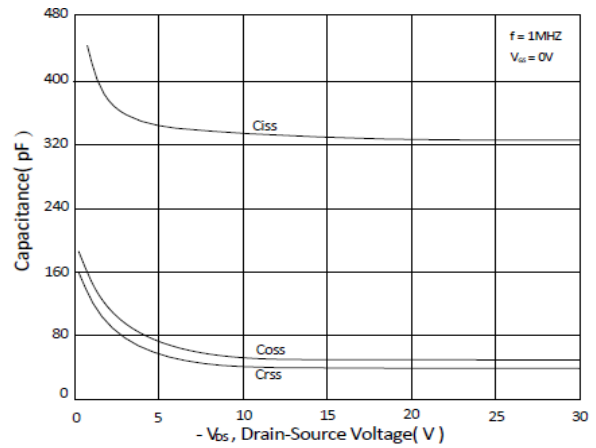

Figure 9. Maximum Safe Operating Area

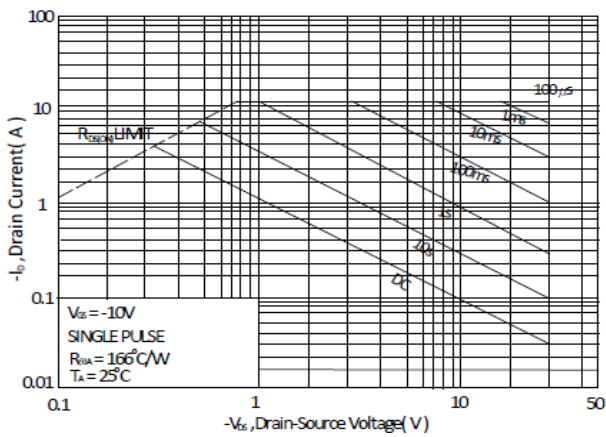

Figure 10. Maximum Drain Current vs. Case Temperature

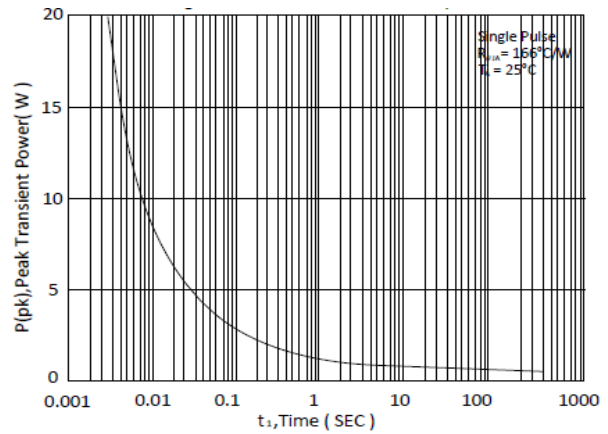
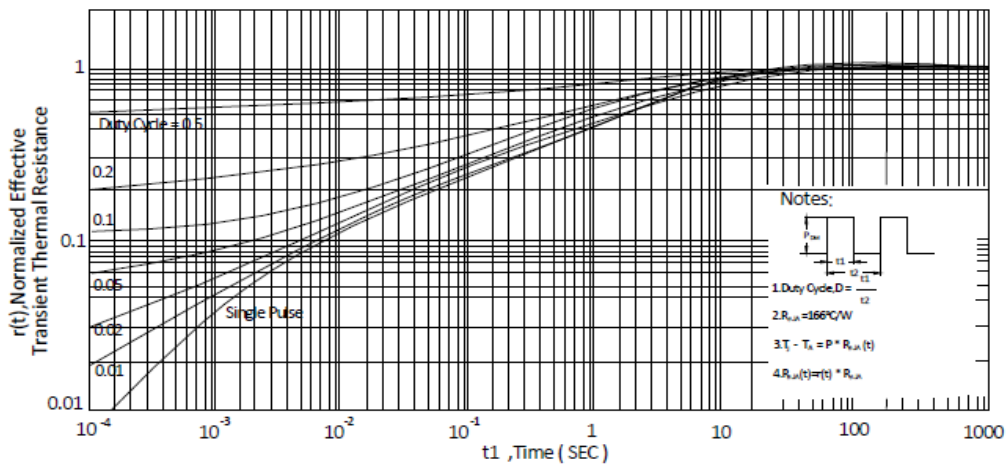
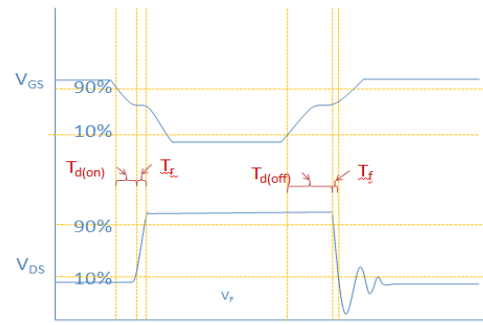
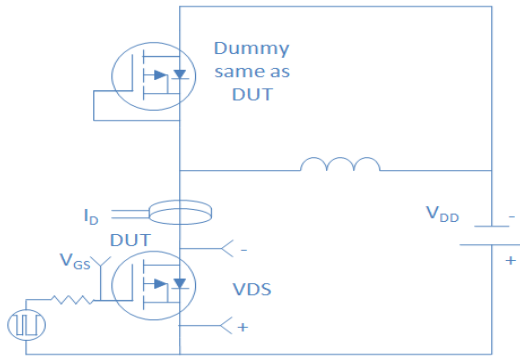

Figure 11. Normalized Maximum Transient Thermal Impedance, Junction-to-Ambient



Inductive switching Test



Gate Charge Test

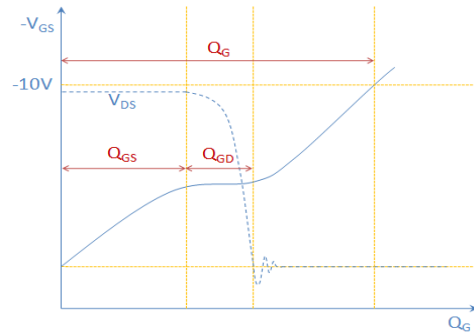
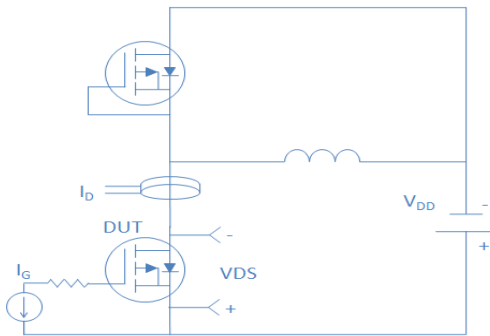

Uclamped Inductive Switching (UIS) Test

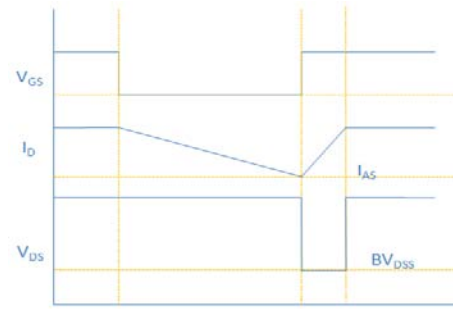
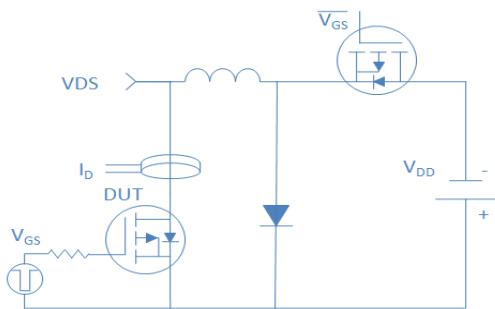

Diode Recovery Test

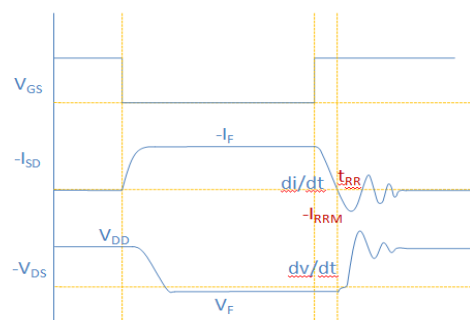
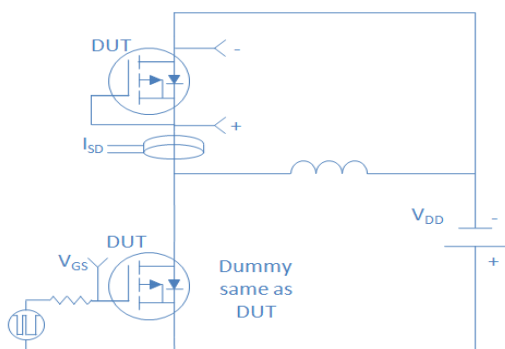

Package Outline

SOT-23, 3leads

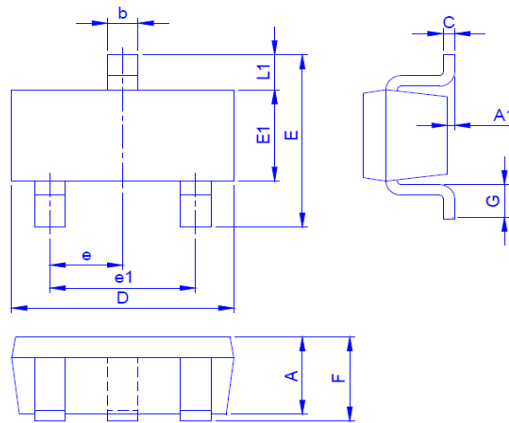

Dimension in mm

Dimension	A	A1	b	C	D	E	E1	e	e1	F	G	L1
Min.	0.70	0	0.3	0.08	2.80	2.25	1.2	0.90		0.80	0.3	0.50
Typ.					2.90			0.95	1.9			
Max.	1.15	0.1	0.5	0.20	3.02	3.00	1.7	1.00		1.25	0.6	0.75